



LAMY
RHEOLOGY
INSTRUMENTS

USING MANUAL
RM 200 CP4000 PLUS



CONTENTS

1	INTRODUCTION	3
1.1	COMPONENTS	4
1.2	GENERAL VIEW OF YOUR DEVICE	5
1.3	CONNEXIONS	8
1.4	SPECIFICATIONS	9
1.5	INSTALLATION	10
2	GETTING STARTED	11
2.1	STATE ICONS	11
2.2	PRIMARY CONCEPTS	12
2.2.1	MAIN MENU	12
2.2.2	MEASURE	12
2.2.3	PROGRAMS	15
2.2.4	VIEW RESULT	18
2.2.5	ZERO SETTING	20
2.2.6	REMOTE CONTROL	20
2.2.7	PARAMETERS	21
2.2.7.1	LANGUAGES	21
2.2.7.2	DATE / HOUR	22
2.2.7.3	SOUNDS / STANDBY / LIGHTING	22
2.2.7.4	USER NAME	23
2.2.7.5	UNITS	25
2.2.7.6	MEASURING SYSTEM	25
2.2.7.7	LOCKED MODE	26
2.2.7.8	ZERO SPEED	28
2.2.7.9	MISCELLANEOUS	28
2.2.7.10	DENSITY	29
2.2.7.11	PRINTING	29
2.2.7.12	SERVICE	31
3	MEASURING WITH YOUR DEVICE	30
3.1	INSTALLATION OF MEASURING SYSTEM	30
3.2	TEMPERATURE SETTING	32
3.3	GAP SETTING	32
4	VERIFICATION OF YOUR DEVICE	35

1. INTRODUCTION

The RM 200 CP4000 PLUS is a device able to measure the viscosity, which is the capacity of a product to resist to the flow.

The fluid is forced to a shear rate (rotational speed) and the shear stress (motor torque) is measured. The values of shear rate and shear stress then make it possible to calculate the viscosity using the Newton equation and the constants associated with the mobile used.

$$\text{Equation of Newton is: } \eta = \frac{\tau}{\dot{\gamma}}$$

With η for viscosity in Pa.s, τ for shear stress in Pa and $\dot{\gamma}$ for shear rate in s^{-1} .

Shear stress and shear rate are calculated by using constants of each measuring system as:

$$\tau = M \times K_{\tau} \text{ with } M \text{ for motor torque in mNm and } K_{\tau} \text{ in Pa/mNm.}$$

$$\dot{\gamma} = n \times K_D \text{ with } n \text{ for rotational speed in rpm and } K_D \text{ in } s^{-1}/\text{rpm.}$$

The viscometer calculates the viscosity by dividing the shear stress by the shear rate for each measuring point. The K_{τ} and K_D constants used depend on the measuring system selected for the measurement.

Viscosity depends on the temperature, then it must be essential that all viscosity values are associated to a reading of the sample temperature, in order to compare viscosity for different samples.

There are some products for which the viscosity, to a constant temperature, stay unchanged, even if we change the shear rate. Those samples are named **Newtonian fluids**, i.e. : Oils, Water, Glycerol, etc... However, many substances have a variation of viscosity in function of speed of shearing, and the Flow Behaviour of those samples could be determined with measuring instruments able to set many speeds of rotation.

The viscometer is constituted with a continuous current motor and an optical encoder, in order to warranty a great accuracy of rotational speed, on all torque range.

The viscometer has an easy touch screen display, on which you could read the **speed, shear rate** (according to spindle) **measuring spindle** reference, the measured torque and the dynamic **viscosity in mPa.s (=cPoises) or Pa.s**.

The Viscometer RM 200 CP4000 PLUS can be used with different measuring system. You will find below a list of compatible measuring system with this viscometer:

- **MS CP:** Measuring systems cone or plate compatible with DIN 53019 / ISO 3219 / ASTM D4278-D7395 (316L Stainless Steel). These systems make it possible to set the shear rate in order to carry out viscosity measurements or to obtain curves to study flow behavior, yield stress or thixotropy. They are particularly suitable for measurements on very small quantities for control or development of homogeneous products with or without particles (size <100 μ m), guaranteeing easy cleaning. Usable only with temperature unit CP-1 PLUS.

1.1. COMPONENTS

Viscometer is delivered inside a foam protection to avoid any problem during transport. RM200 CP4000 PLUS is delivered mounted. You will find some cable, measuring system (according to order) and some tools for installation and using.

In detail, you will find different part in your box as shown below.



RM100 CP2000 PLUS



Cable and power supply for measuring head



Cable for CP2000



Tool for levelling of RM100 CP2000 PLUS



Level indicator



Cable for connexion of measuring head with CP2000 temperature control.



Cable for connexion of measuring head with CP4000 for lift control.



Bottom plate 40mm or 60 mm (according to order)

1.2. GENERAL VIEW OF YOUR DEVICE

Once your device will be mounted and installed, it looks like this;



- TOUCH Screen

The new PLUS series is equipped with a 7" colour touch screen. It gives you greater working comfort and a clearer view of your data and analysis results.

- On / Off Switch

Always with the aim of improving your experience, LAMY RHEOLOGY has decided to equip all of its PLUS range with a luminous and design switch. It has been placed in the centre of the device for greater intuitiveness.

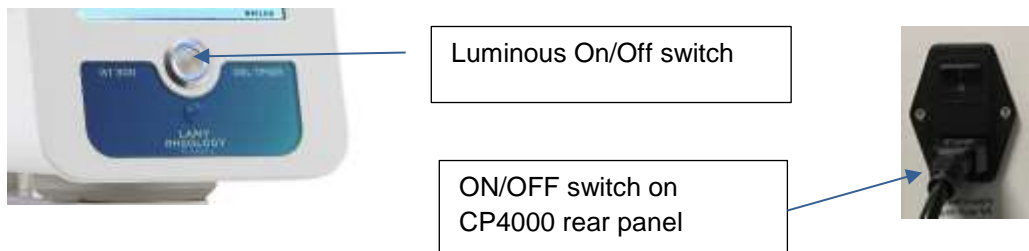

- Aluminium arm

The measuring head is fixed to the arm with tow screw.

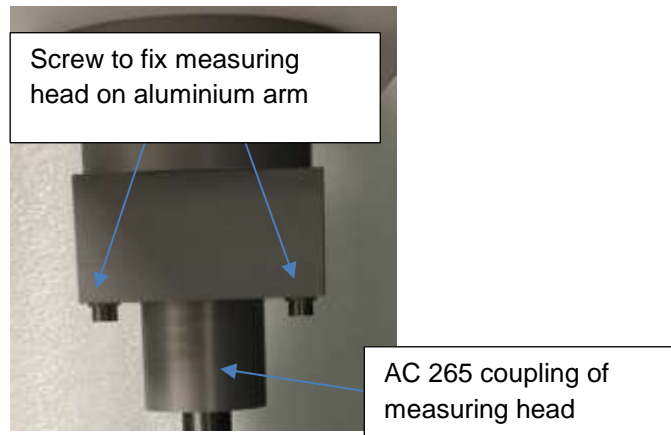

- Stainless steel rod

The support rod is made of stainless steel for a solid hold of the measuring head. It has a very long life. An endless screw in the middle acts as a lift to move the arm and the measuring head.

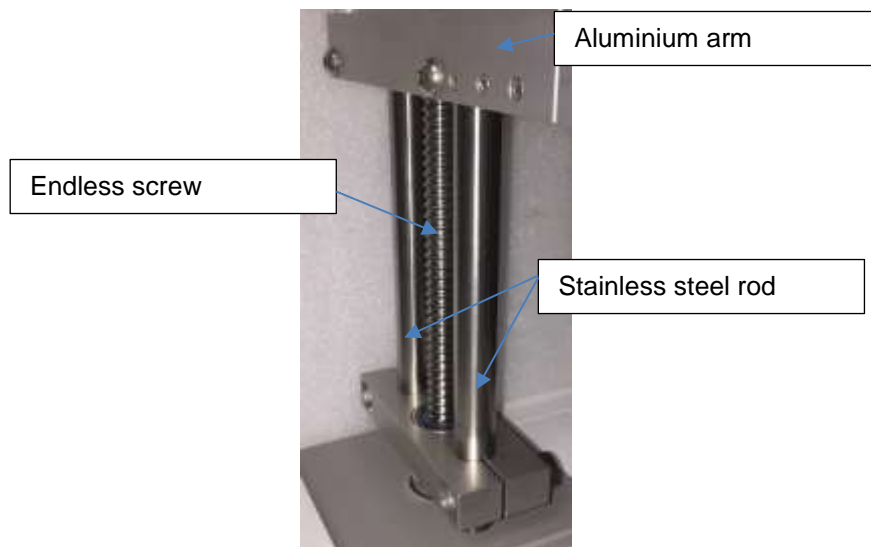

- Temperature unit CP4000

This device regulates the temperature of your sample. It is equipped with a display / regulator (programmer for certain model) OMRON. It exists in Peltier or electric version.

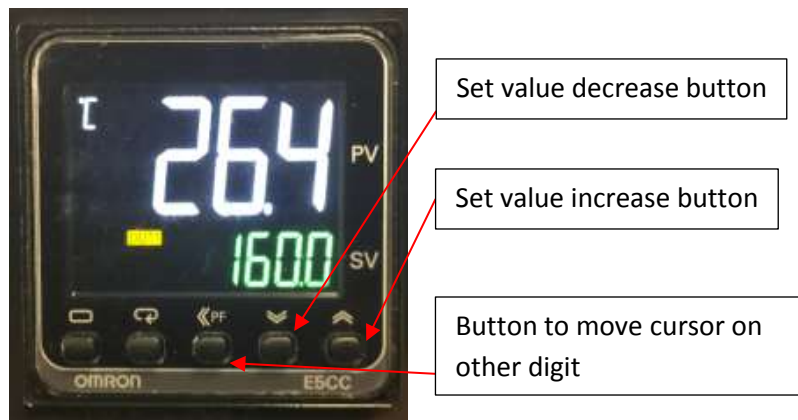

The lower plate is interchangeable to accommodate the diameter of the measuring geometry.



1.3. CONNEXIONS

According to your order, rear panel of device get this available connexions.

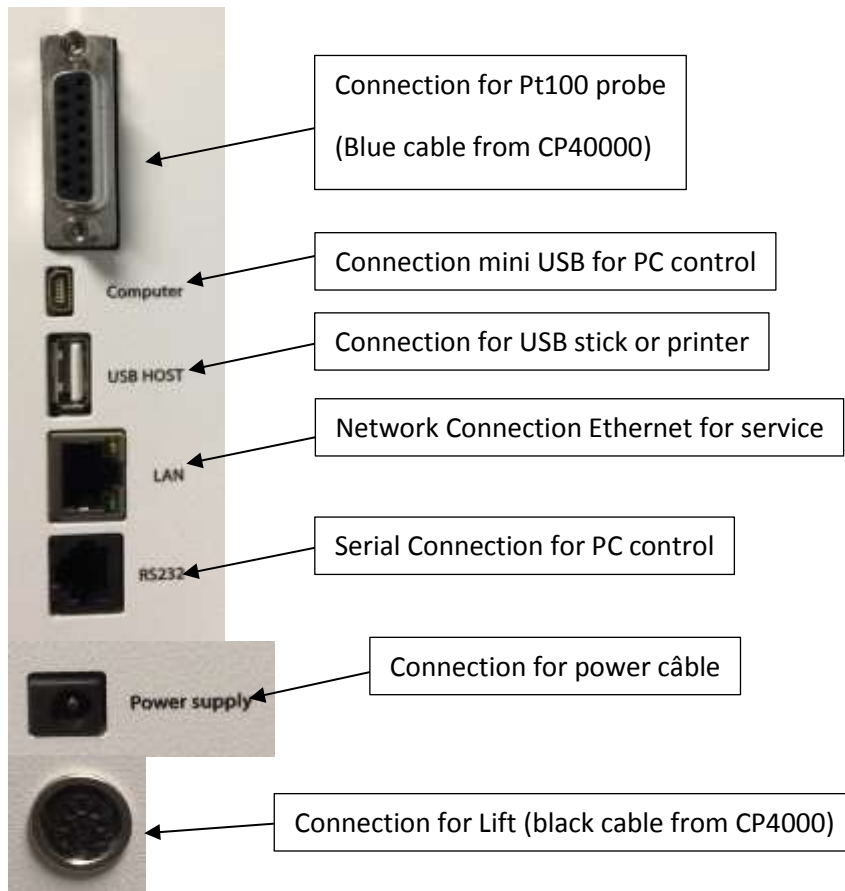

The rear panel of CP4000 Temperature unit get this connections:

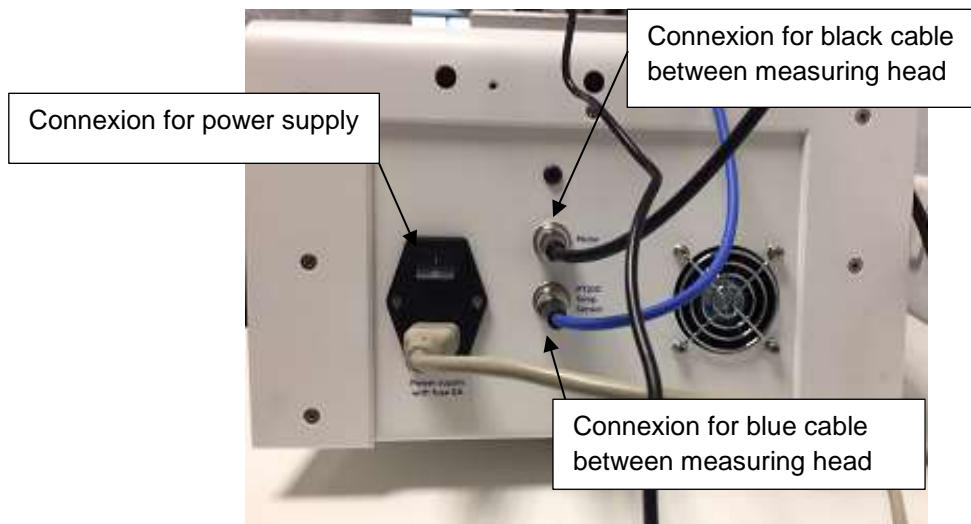

1.4. SPECIFICATIONS

Type of instrument: Rotating springless rheometer with imposed speeds and 7" Touch screen

Rotation speeds: Unlimited number of speeds between 0.3 and 1500 rpm

Torque range: From 0.05 to 30 mNm

Temperature: Temperature range from – 20°C to + 300 °C (according to models)

Accuracy: +/- 1 % of the full scale

Repeatability: +/- 0,2 %

Display: Viscosity – Speed – Torque – Time –Temperature - Choice of viscosity units: cP/Poises or mPa.s / Pa.s – Shear rate

Language: French/English/Russian/Spanish

Compatible measuring system: MS CP

Supply voltage: 90-240 VAC 50/60 Hz

Analog output: 4 – 20 mA

PC connections: Port RS232 and USB

Printer connection: USB Host Port – Compatible PCL/5

Option: Software (PN 311002)

Dimensions and weight: Head: L180 x W135 x H250 mm, CP 4000: D610 x W340 x H650 mm, Weight: 22 kg

This is the available models:

Part Number Instrument	Designation Instrument
N240250	RM 200 CP4000 PLUS RHEOMETER PELTIER AIR-AIR (+10 to + 70 °C)
N240251	RM 200 CP4000 PLUS RHEOMETER PELTIER AIR-AIR (+10 to + 70°C) with programmer
N240500	RM 200 CP4000 PLUS RHEOMETER PELTIER AIR-AIR high power(+5 to + 80 °C)
N240501	RM 200 CP4000 PLUS RHEOMETER PELTIER AIR-AIR high power(+5 to + 80 °C)+ prog
N240600	RM 200 CP4000 PLUS RHEOMETER PELTIER AIR-AIR (+10 to +120°C)
N240601	RM 200 CP4000 PLUS RHEOMETER PELTIER AIR-AIR (+10 to +120°C) with programmer
N240800	RM 200 CP4000 PLUS RHEOMETER liquid peltiers (-20 to + 120 °C)
N240801	RM 200 CP4000 PLUS RHEOMETER liquid peltiers (-20 to + 120 °C) w ith programmer
N240900	RM 200 CP4000 PLUS H RHEOMETER (Room to +300°C)
N240901	RM 200 CP4000 PLUS H RHEOMETER (Room to +300°C) with programmer

1.5. INSTALLATION

Install the CP4000 on a solid bench. Place the level on the plane and adjust the level using the 2 keys provided by playing on the three adjustable feet in height.

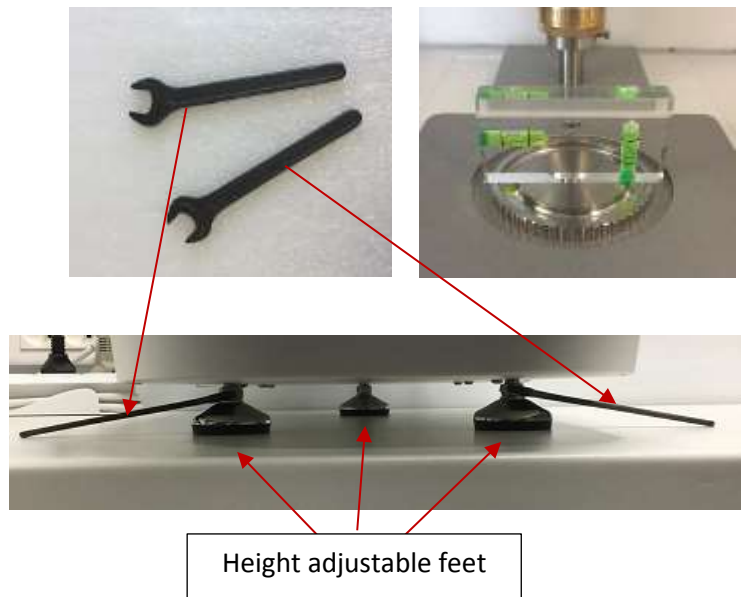

Connect the power cable. Connect the temperature reading cord (blue): SUB-D 15 connector on rear of the RM PLUS to the DIN plug on the back of the CP4000 stand.

Connect the black cable for lift control between measuring head and CP4000.

Connect the RM200 PLUS and CP4000 power cable.

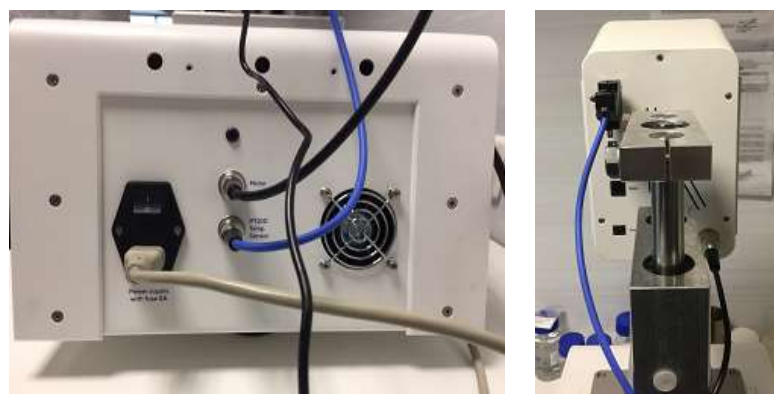







2. GETTING STARTED

Once power cable has been plugged on rear panel of device (see section 1.3), you can click on button to switch on your device (see section 1.2).

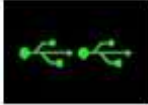
2.1. STATE ICONS

Once your device is switched on, you will see some icons on Touch Screen.

	No Device is connected to the instrument.
	Only one Device is connected to the instrument.
	Two Devices are connected to the instrument.
	Give you the temperature of probe in the sample.
	Enable to go to parameters of instrument.
	Enable to come back to Main Menu.
	Enable to come back to previous menu.

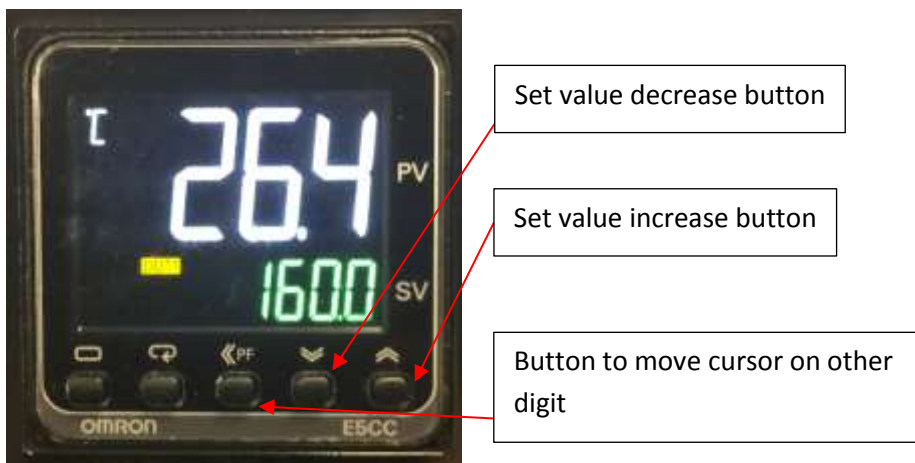

2.2. PRIMARY CONCEPTS

2.2.1. Main Menu

Main menu enable to you to browse between different tabs of your RM 200 CP4000 PLUS. Acces is always available by clicking 

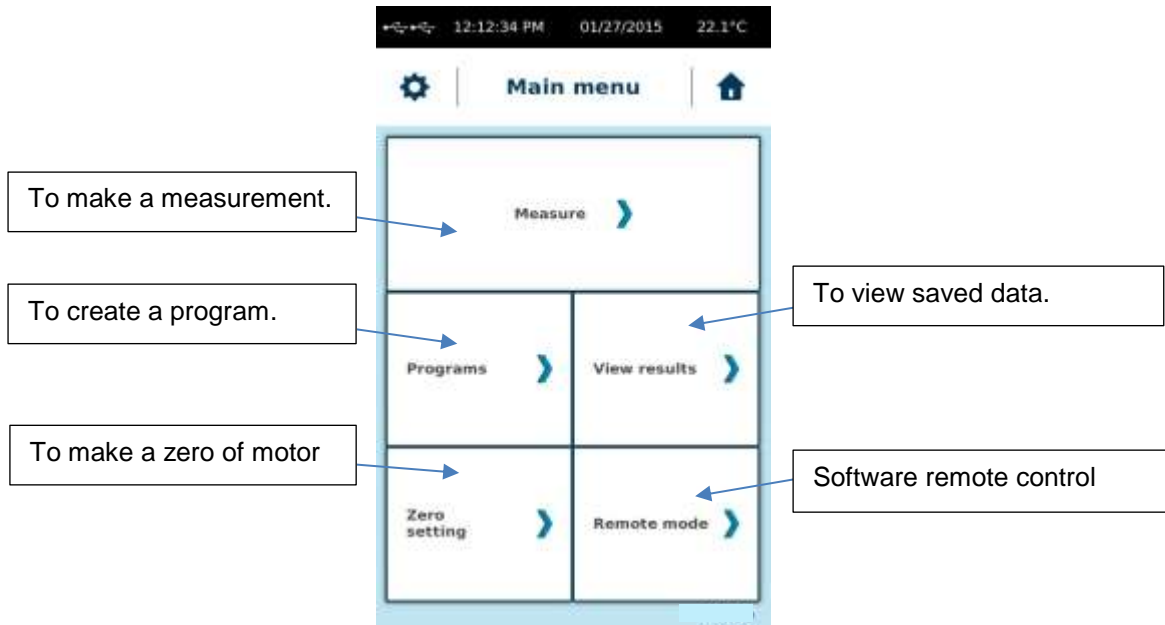

2.2.2. Measure

Before making a measurement, you will need to install your measuring system and make a zero gap then go to the measurement position. Please see section 3.1, 3.2 and 3.3 before making your measurement. Don't forget to make a zero of motor (see section 2.2.5).

Then you click on "Measure tab", you will get this window

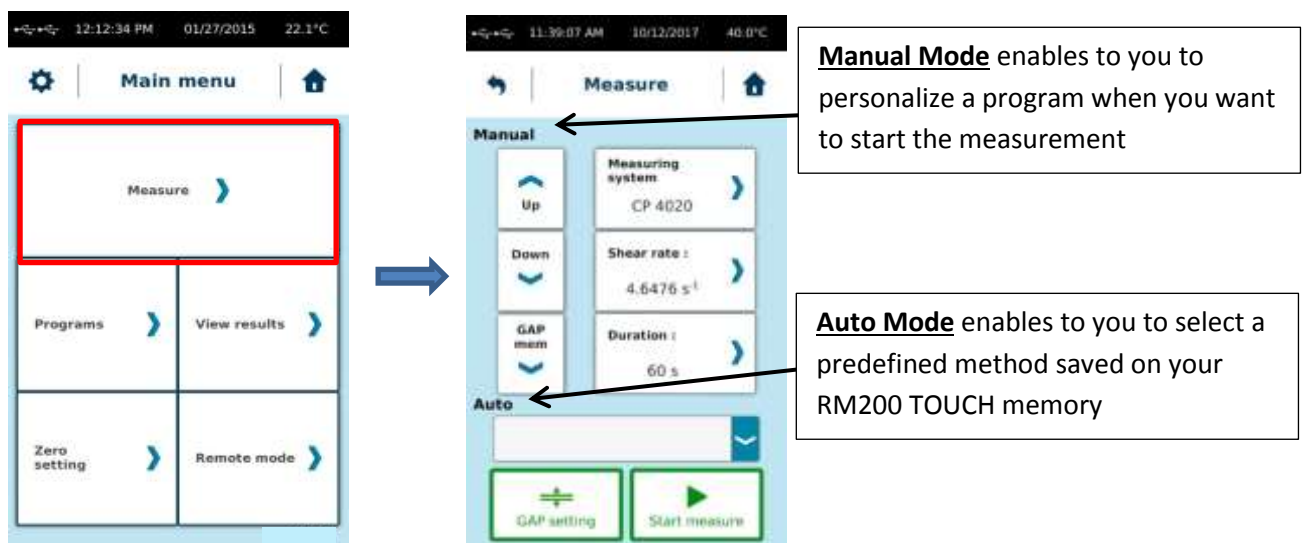

Arrows and elevator functions are explained in paragraph 3.

Manual Mode enables to choose your measurement parameters like «Measuring System », « Speed or shear rate» then « Time of measurement ».

Click Start to start your measurement. When it is finished, you will see the results of your measurement and can choose to save and / or print your result (if a printer is connected).

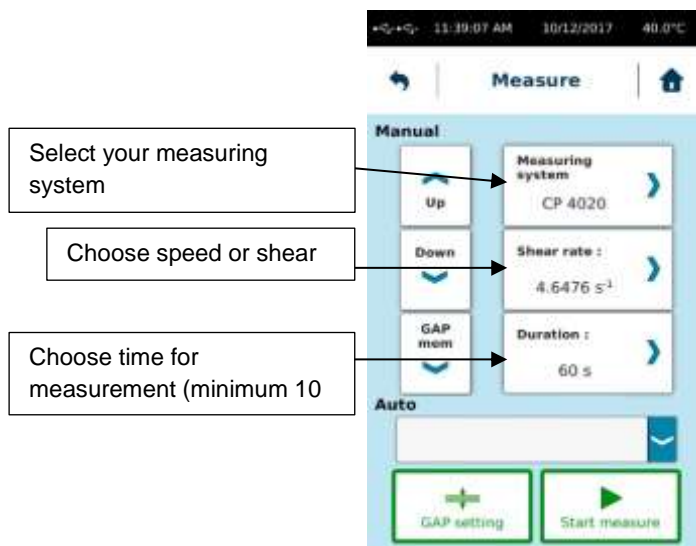

Rq : If « Time » = 0, you could modify « speed » during the measurement. This could help you to define the best conditions to work on your sample.

If your measuring system is not in list, you may have to create it. Please refer to section 2.2.7.6.

Choice between “Speed” or “Shear rate” is according to your measuring system. For MS CP, you should have only possibility to set the shear rate. If you need to know what is the corresponding speed then you are using shear rate, you have to use constant K_D of your measuring system (information available in section 2.2.7.6).

$$\text{SPEED} = \text{SHEAR RATE} / K_D$$

With speed unit in rpm, shear rate in s^{-1} and K_D is rpm/s^{-1} .

Auto mode allows you to select pre-recorded programs. Select the program from the list and click "Start" to start your measurement. The display automatically adjusts to show the current measurement. Depending on the type of program selected (see section 2.2.3), the instrument will ask you to save your measurement at the end (one-point method program) or before measurement begins (ramp method program).

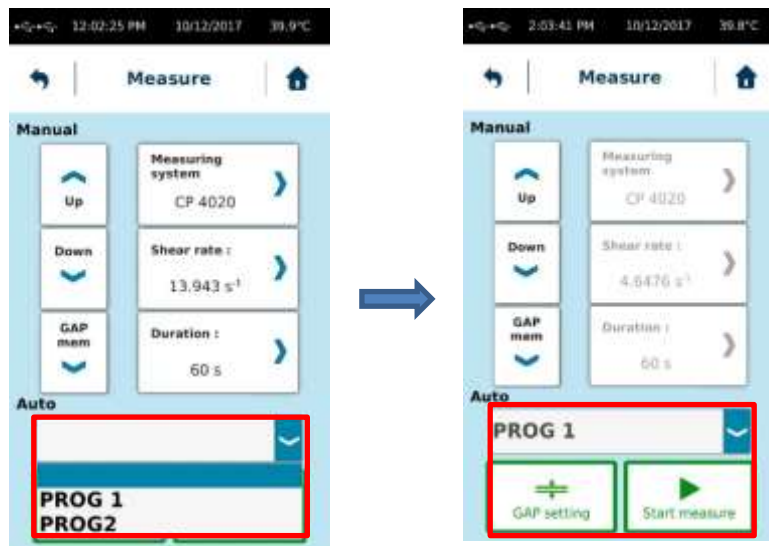

Then your settings are ok, you can click “Start” to start your measurement. While your measurement, you will see a torque gage. Please try to not be closed to the upper and lower limit. Please increase speed or take a bigger measuring system if you are close to the lower limit. Please decrease speed or choose smaller measuring system if torque reading is close to the upper limit. If you are using a program, please change settings on it.

Picture below show how should be the closer position regarding lower limit.

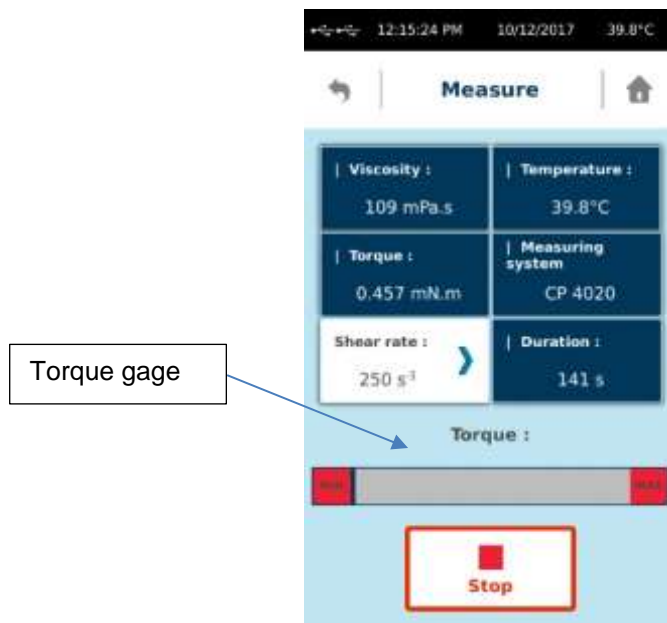

Then your measurement is finished, you will get this windows below. You will find all data you need and get possibility to save them into internal memory or to print it (if a printer is connected). If you choose “Save”, viscometer will ask you to give a name of your measurement. You will have after possibility to read it later (see section 2.2.4.).

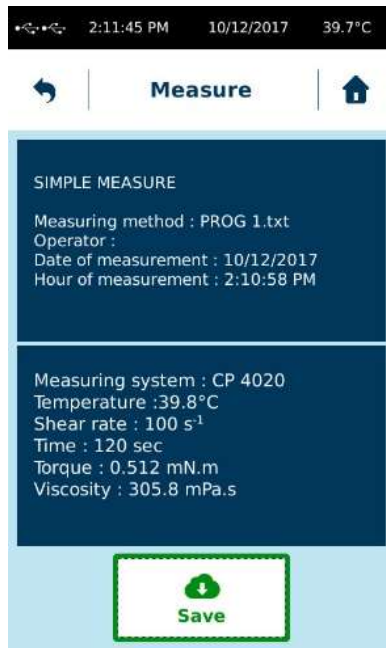

2.2.3. Programs

With **Programs** tab, you could define parameters for your standard measuring program and also delete it. We have two kind of program. “One point method” and “Ramp method”

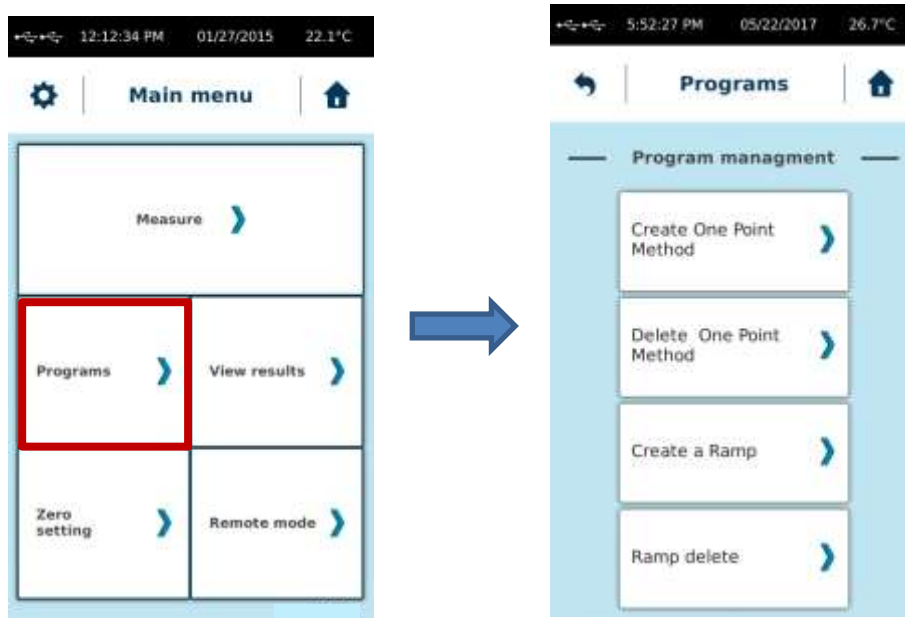

In One point method, you will have one viscosity value at one speed. With ramp method, you will have possibility to get flow and viscosity curve over shear rate (with compatible DIN measuring system) or speed.

When your Program is created, you will find it in **AUTO** list of **Measure** tab.

2.2.3.1. Create or delete one single point measuring method

Click on “Create One Point Method” to start programming

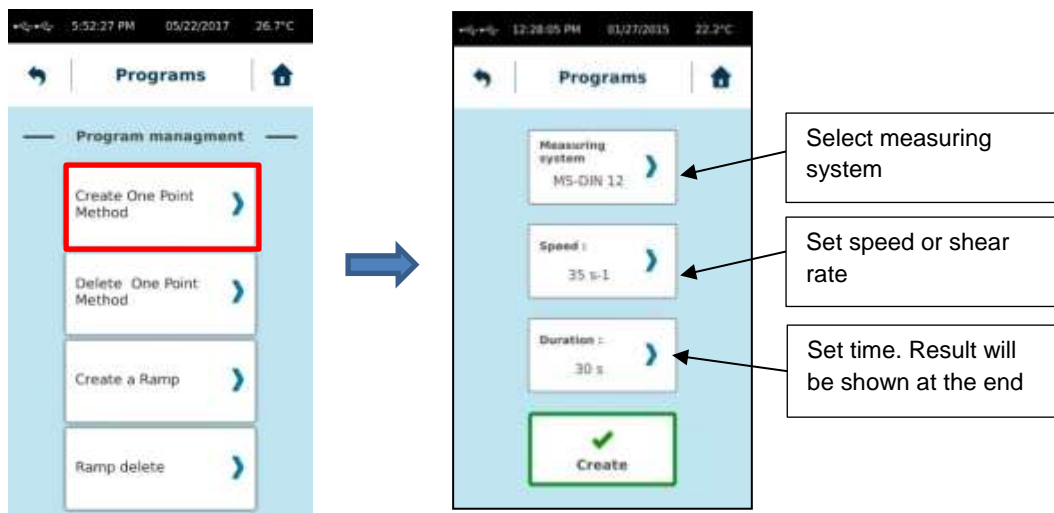

Then you click on create, you will get this screen where name of program need to be given.



To delete “One Point Method”, please do like this

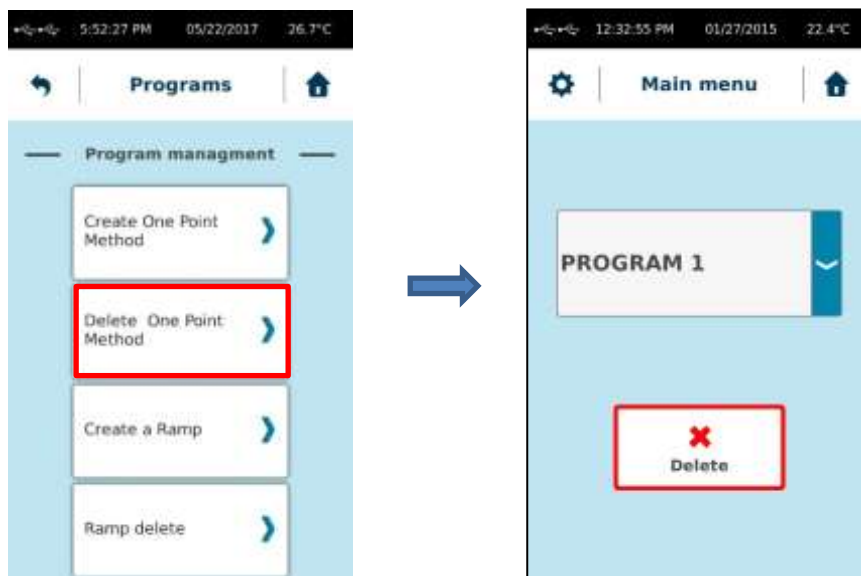

2.2.3.2. Create or delete ramp measuring method

As you will see, this menu allow you to create a ramp method to get viscosity for different speed or shear rate (according measuring system). You will be able to set pre-shearing with time or also regression fitting to get result as yield stress.

Ramp method can be set as only one rising ramp or with hold time for plateau and down ramp.

The image shows two screenshots from a mobile application. The top screenshot shows the 'Programs' menu with 'Create a Ramp' highlighted in a red box. A blue arrow points to the second screenshot, which is the 'Create Ramp' configuration screen. This screen has several settings with callouts:

- Select measuring system:** MS-DIN 11
- Set pre-shearing time:** 15 s
- Set first shear rate of ramp:** 20.0 s⁻¹
- Set number of point for first ramp:** 10
- Set pre-shear rate:** 20.0 s⁻¹
- Set final shear rate of ramp:** 100.0 s⁻¹
- Set number of point for first ramp:** 60 s
- Set time to hold final shear rate between up and down ramp:** 20 s
- Select if you want to fit curve with regression model:** Curve Fitting Enable
- Select to do only rising ramp:** Single rampe enable

At the bottom of the configuration screen is a green 'Create' button with a checkmark icon.

If you select “Curve fitting Enable” you will see this windows then you will click on “Create”.

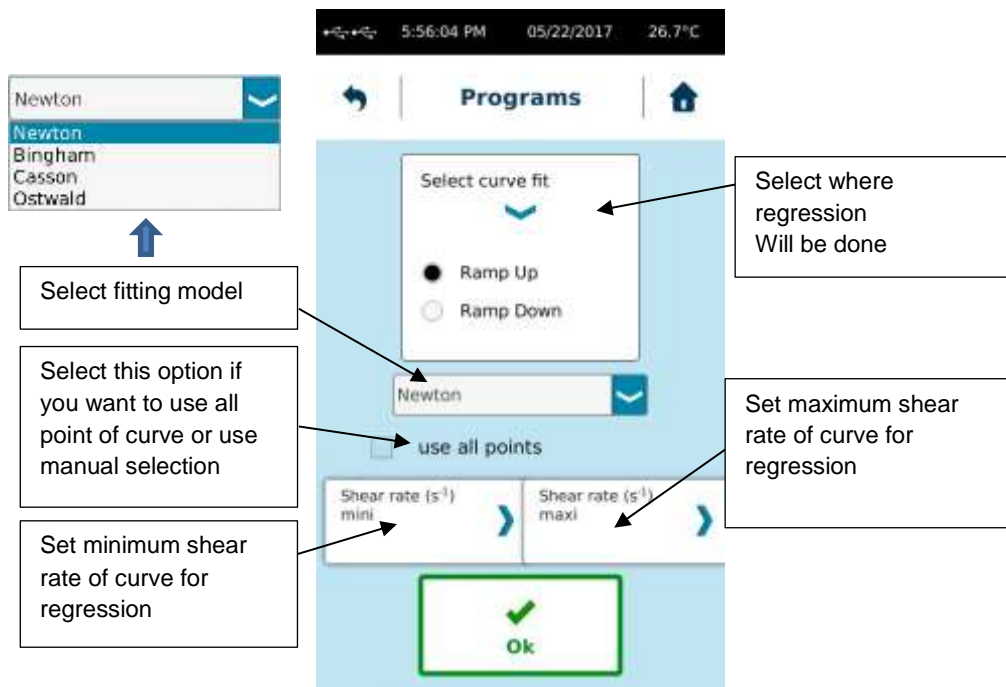

Then you click on “OK” you will have to enter name of program. To delete of “Ramp method”, please do as for “One point method”.

2.2.4. View Result

This menu allow you to read or delete data from internal memory. Press on « View results » tab in Main menu.

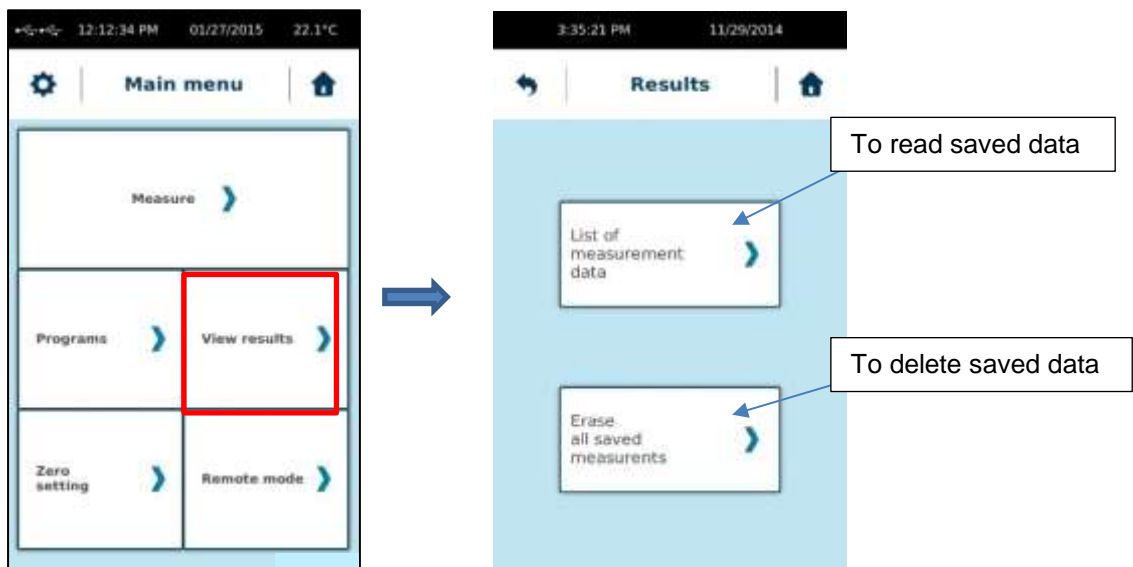

2.2.4.1. Read saved data

By click on tab “List of measurement data” you could see all saved measurement made with your RM 200 CP4000 PLUS. You could select which one you want to read.



Then you selected a measure, you will see result and get possibility to print it if a printer is connected.

By clicking on “Global Export”, you will have possibility to transfer all saved measure on USB stick (if connected).

The format of the data generated and saved by the viscometer is ASCII (* .csv). Once your data has been copied to the USB drive, you can open the files using the EXCEL spreadsheet. To do this, simply copy the data from the USB key to your computer. Then open Excel, choose "File", "Open", taking care to select "All files *. *". Excel will offer you to convert your data by displaying three successive windows. Be careful not to change the options offered except on the second where it will be necessary to choose the option "semicolon" for the separation of the columns. You can then see your measurement results with the possibility to save a new file in Excel format.

2.2.4.2. Delete saved data

By click on tab you could delete saved measure one by one as you want from your RM 200 CP4000 PLUS memory.



Then you click on “Delete”, saved data will be completely deleted from internal memory without any new confirmation.

2.2.5. Zero setting

The zero setting allows you to calibrate your RM 200 CP4000 PLUS to take account of the engine's empty friction. This operation must be done without measuring system. The rotational speed for zero adjustment is set at the factory. But if you want to change it, you can change it by going to the "Parameters" menu (see section 2.2.7.8). The shifting allows you to give you much more accurate measurements at specific speeds. The best speed for zero setting should be the same as for your measurement.



Then zero is finish you can click on OK and internal motor friction will be automatically saved inside memory of viscometer. If problem occur during zero setting, please try again. If problem still present, please contact your local distributor or society LAMY RHEOLOGY.

2.2.6. Remote mode

This mode enables to drive RM 200 CP4000 PLUS by external VISCO RM software, supplied on option.

You must select the type of connection: USB or RS232 and connect the appropriate cable (delivered with software) to the computer, open the software, select the right COM port you're using on “SYSTEM” “CONFIGURATION” menu of software and press “Start” to establish connection with external software.



Rq : With mini USB connection, respect strictly the order to start, and if any communication is possible re-connect the USB cable on computer and wait it is recognized before start the communication.

2.2.7. Parameters

This parameters menu allow you to change settings of your device. It is reachable by clicking on icon “wheel” in upper left corner of touch screen.

This icon is only available then you are in “Main menu”.

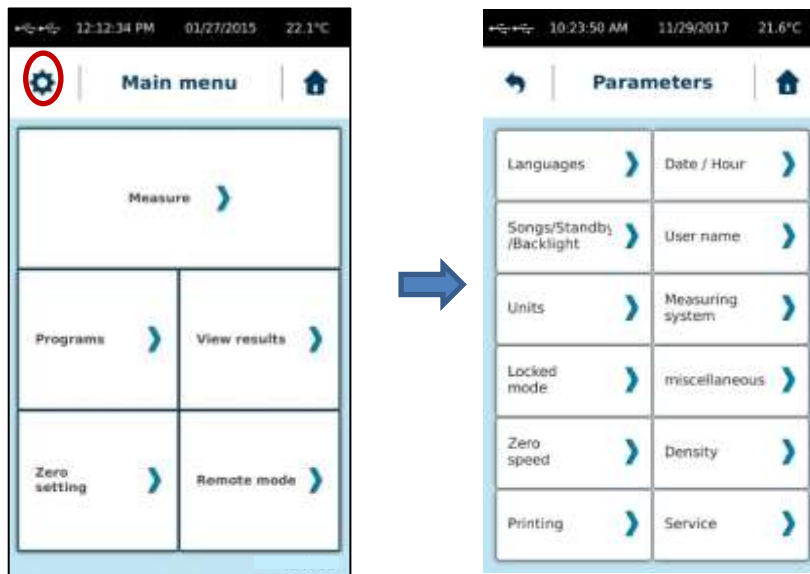

2.2.7.1. Languages

Enable you to select language of your RM 200 CP4000 PLUS. You have choice between French, English, Russian and Spanish. Then you have selected your desired language, you have to click on “Ok” and device will reboot automatically to show new language. In this menu you will be able to see Firmware version of your device.

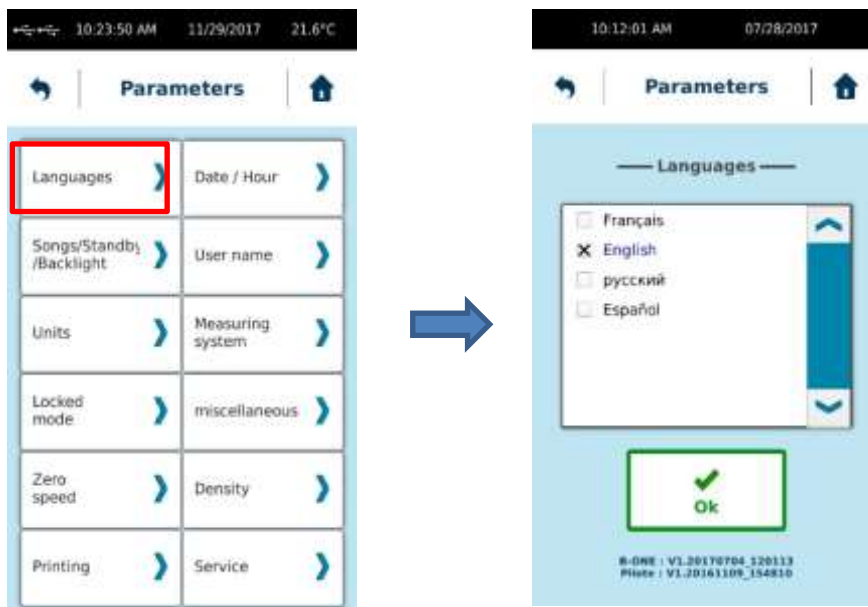

2.2.7.2. Date / Hour

Enable you to adjust hour and date of your RM 200 CP4000 PLUS.



2.2.7.3. Sounds/Standby/Lighting

Allow you to modify sounds, lighting and activate or not the Standby mode of your RM 200 CP4000 PLUS.

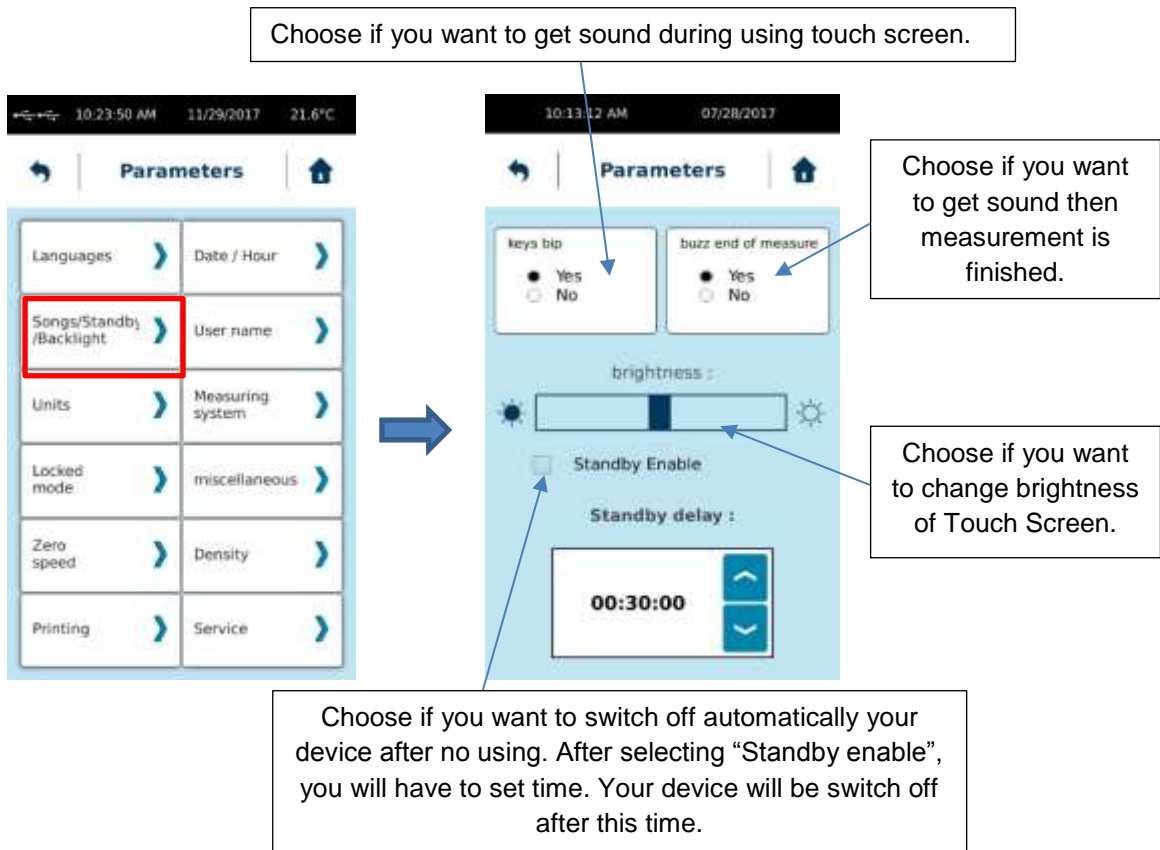

2.2.7.4. User Name

Operator mode will allow you to create different operators for your RM 200. The use of the operators makes it possible to identify the person making the measurement. Operator management must always begin with the creation of the first account, which will become the administrator and thus create or delete another operator account.



After specifying the name and password, the administrator will be named in red in the list.



You can now create another operator. The account of an operator may or may not be associated with a password (here called PIN code).

To delete an account, the administrator account must be used. Select the account you want to delete from the list and click on "Delete user name".



To use the operator accounts you must activate the mode. Device will ask you to select user name you want to use. By returning to the Main Menu, you will see the name of the operator in use. By clicking on the arrow below the name of the operator, you can switch off the RM 200 or change operator.

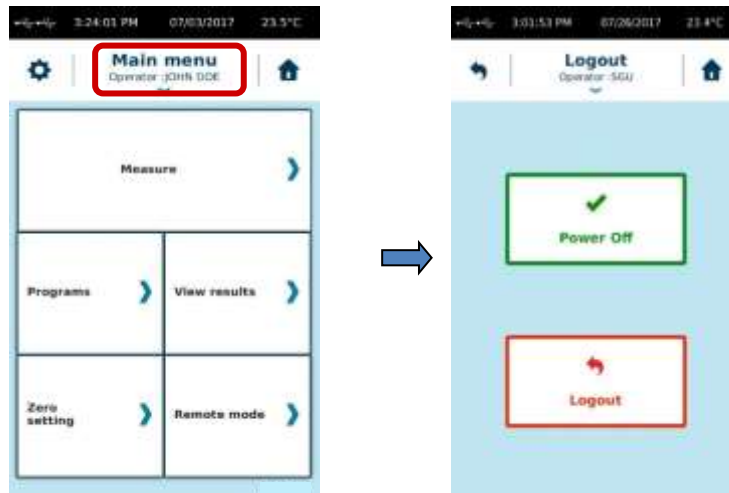

If the instrument is switched off while operator mode is activated, device will ask you to select the operator you want use then device will be switched ON.



2.2.7.5. Units

Enable to you to change unit of viscosity values.

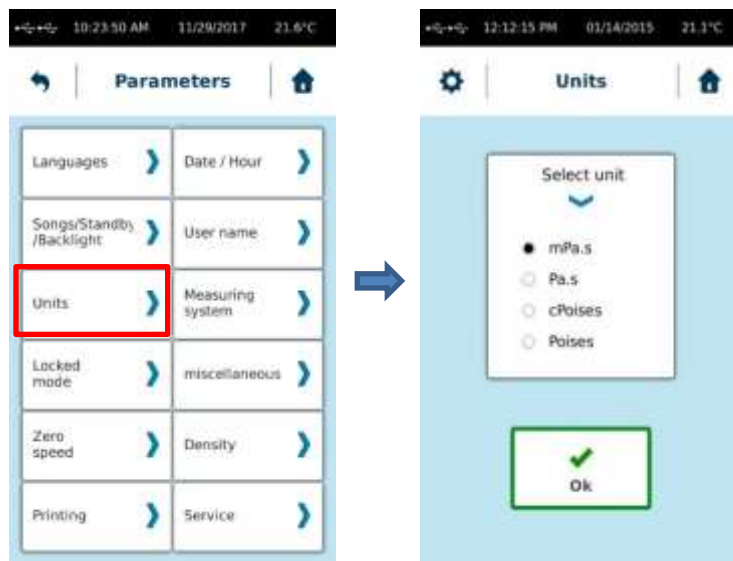

2.2.7.6. Measuring System

Allows you to add or remove a Measuring System.



To create a measurement system, the instrument will ask for both constants and the name. You will find below list of measuring system compatible with your device and corresponding constant. You are not allow to change constant of existing measuring system. If you want to use new constant, you have to create a new measuring system with name as "Copy of..." and enter constant you want to use. Please remember that Constant K_D is use to convert speed in shear rate and $K_{\tau_{au}}$ to convert torque in shear stress. As shear rate and shear stress are using to calculate viscosity value, if you use different constant value, you will get different viscosity result.

MS CP

SYSTEM	Ktau / 1 mNm in Pa	Kd / 1 RPM in S-1	Ri / Ra
CP 2005	477.5	12	1
CP 2015	477.5	3.8	1
CP 2020	477.5	3	1
CP 2045	477.5	13.3	1
CP 2405	276.3	12	1
CP 2420	276.3	3	1
CP 2445	276.3	13.3	1
CP 2520	244.5	3	1
CP 3020	141.5	3	1
CP 3520	89.1	3	1
CP 4005	59.7	12	1
CP 4015	59.7	3.8	1
CP 4020	59.7	3	1
CP 4040	59.7	1.5	1
CP 4221	51.6	3.8	1
CP 4530	41.9	2	1
CP 5005	30.6	12	1
CP 5010	30.6	6	1
CP 5020	30.6	3	1
CP 6005	17.7	12	1
CP 6010	17.7	6	1
CP 6020	17.7	3	1
PP 25 0.5	326	2.618	1
PP 25 (1mm)	326	1.309	1
PP 25 (2mm)	326	0.654	1
PP 40 (0.5mm)	79.5	4.188	1
PP 40 (1mm)	79.5	2.094	1
PP 40 (2mm)	79.5	1.047	1

For other measuring system, please contact LAMY RHEOLOGY.

2.2.7.7. Locked Mode

This option allow you to block measuring parameters and settings of your device. It should be set by an administrator or responsible of the device.

This function is not comparable to the "User name" menu (please see section 2.2.7.4). It should be use if you want to protect few settings on your device. All settings will be not locked by this function. You will see below which settings are concerned.

This function will block also parameters for measure. In this way, if you want to use all the time same parameters for measurement, you should enable this locked mode to be sure that nobody will change settings for measurement.



When you click "Enable", the RM 200 will ask you to save a 4-digit code that will be required to disable this protected mode. Each activation is independent and can be done with a different code. The protected mode is indicated by the presence of a padlock-like icon. **BUT TO DISABLE THIS LOCKED MODE, YOU SHOULD USE 4-DIGIT CODE USED TO ENABLE IT.** Once protected mode is activated, you will see this icon on RM 200 Screen (see picture below). Protected mode protect programs, measuring parameters and some menu as shown on pictures below.



To disable protected mode, you have to go again in service and "Locked mode" and click on disable. You will have to use password.

2.2.7.8. Zero Speed

Enable you to adjust the rpm value for the zero adjustment.



You have to use the same speed as for your viscosity measurement. Then zero setting is finished, you have to click “OK” to validate it.

2.2.7.9. Miscellaneous

This menu allow you to choose which temperature sensor will be used by the device (Internal of external). By default, PT100-2 is selected and corresponding to PT100 of CP4000 unit. Pt100-1 is not available on RM 200 CP4000 PLUS.

Allows you to change the maximum torque that will be sent to the analogue recorder that will be connected (oscilloscope or card). This function does not allow to limit the torque of the RM 200 CP4000 PLUS during a measurement.

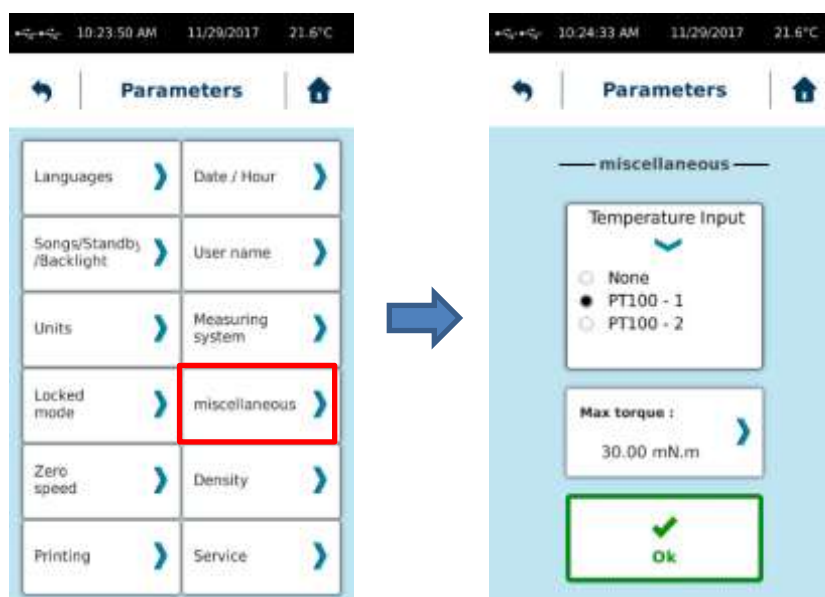

2.2.7.10. Density

Enable you to enter density value of your product in order to measure his kinematic viscosity.



If you set a density value, you will get all the time viscosity in cStoke. Please remove density information if you want to get back Pa.s or Poise for unit of viscosity.

2.2.7.11. Printing

Allows you to connect a printer, print a test page, and choose the print interval time you want during measurement.

The RM 200 can be connected to all printers with a PCL5 print protocol. This includes many A4 printers. The connection is made to the "USB host" port on the back of the instrument. Once the printer is connected, simply click on "Install Printer".



Then you print data at the end of measure or a saved file, you will have only information shown on device screen as final result. If you want to have more data printed, you have to select "Interval printing" time to get data printed between start and end of your measurement.

2.2.7.12. Service

Reserved to LAMY RHEOLOGY engineers.



3. MEASURING WITH YOUR DEVICE

This section will show how use the different measuring system with your device.

Viscometer need to be installed before next section of this manual (see section 1.5).

3.1. INSTALLATION OF MEASURING SYSTEM

Read the installation of your measuring system in the following sections before inserting it on your viscometer. Indeed some measuring systems require the installation of accessory before the insertion of the spindle. And don't forget to make zero of motor before installing measuring system (see section 2.2.5).

Unlike the RM200 PLUS, the CP4000 version can only be used with cone-plane or plane-to-plane geometries. The coupling of the RM 200 CP4000 PLUS is of type AC 265. It is a system allowing the insertion and the quick fixing of the measuring mobiles. A simple vertical action of the ring upwards (release) or downwards (locking) allows easy manipulation of the measuring tool.



Choice of measuring system must be done according to the product to be measured. Favor wide diameters for low viscosities as shown on diagram below.

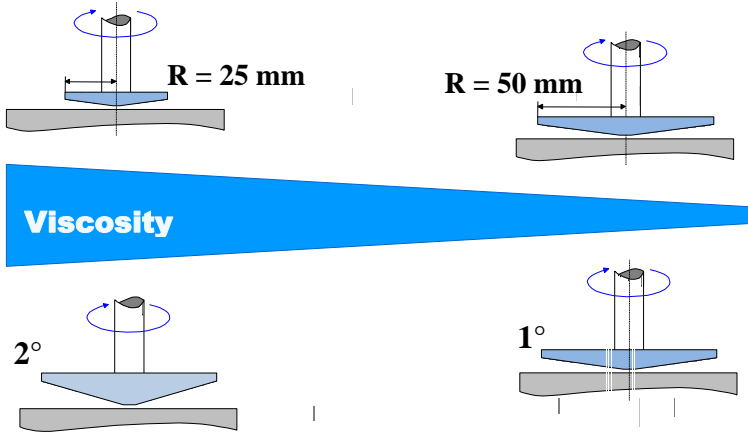

The amount of sample should be sufficient to completely fill the space between the cone and the bottom. In the case of a liquid sample, you can take the recommended volume for the dimensions of your cone-plane (see table below). For thicker samples, you need to draw enough with a spatula or similar tool.

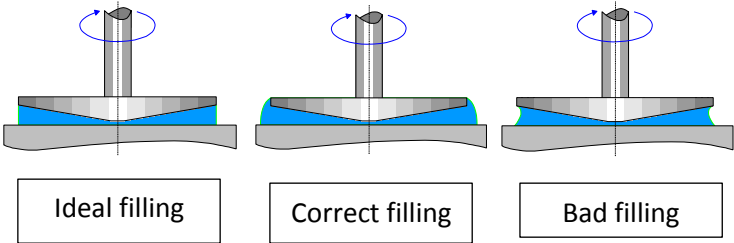

Sample volume for Plate measuring system depends on gap used. But filling need to be perfect as for cone.

Diameter (mm)	Angle (°)	Sample volume (ml)
10	0.5	0.0023
20	0.5	0.018
20	0.5	0.018
20	1.59	0.058
20	2	0.073
24	0.5	0.031
24	2	0.126
40	0.5	0.146
40	1.59	0.465
40	2	0.585
40	4	1.17
50	0.5	0.285
50	2	1.142
60	0.5	0.5
60	1	1
60	2	2
60	3	3

3.2. TEMPERATURE SETTING

The value read on this display is the set temperature. The value read on the screen of the RM 200 CP4000 PLUS is the actual value of temperature.

To change the setpoint, press the arrows to adjust the desired temperature, the new setpoint will be taken into account after a few seconds without validation

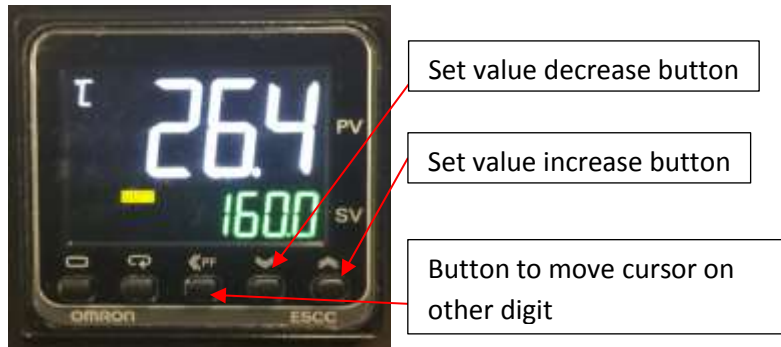

3.3. GAP SETTING

Gap adjustment is required before each measurement. It allows you to realize the contact position (also called zero gap), to memorize the measuring position and to place the geometry at this position in order to realize your measurement.

Elevator functions are available when you select the "Measure" tab on the main screen. Then you are in Measure windows, you can see settings for gap.

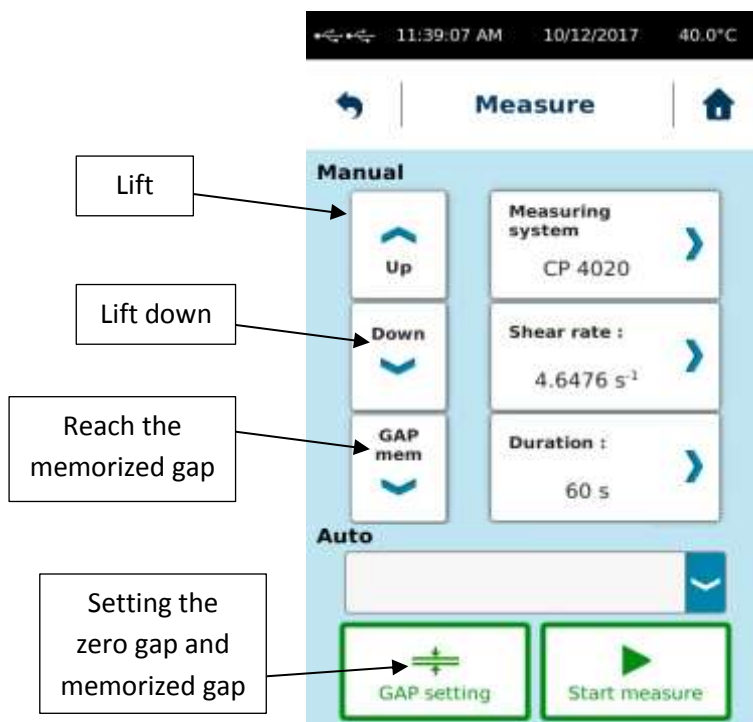

Each Measuring system can have its own positioning gap for measurement. To set this memorized gap or to make zero gap, you have to click on "GAP setting".

Your RM 200 CP4000 PLUS is equipped with an automatic lift device. Setting the zero gap is very important for the measuring position to be as ideal as possible. This adjustment must be done with the mobile, without sample, at the measuring temperature and be renewed temperature is different.

The first step is to select the mobile you have chosen for your measurement by pressing "Measuring System" (see screen on previous page). Indeed, if you change mobile later, the zero gap will no longer be valid and must be redone for the new measuring system you have selected. In the case of a measurement using a program (see section 2.2.2 and 2.2.3), it is preferable to load the protocol by selecting it before setting the zero gap. You must then warm up your measuring platform (see section 3.2). You must also, especially if the set temperature is different from that of the room, put the measuring geometry on the lower plate to put it also in temperature.



When the temperature is stabilized, you must leave your geometry at least 5 minutes in this position.

You can then fix the mobile on the measuring head (see section 3.1) before accessing the next step.

Select "GAP Setting" to access this screen.



Enter the desired measuring position value by selecting "GAP value". For a measuring system with truncation (part number starting with 365...), this value must be set to 0.05mm. For a system without truncation, the position must be set to 0.01mm. For a plate geometry, the measuring position can be set between 0.150 mm and 2 mm.

Once the position has been memorized, press the "down" arrow to reach a position above 1cm from the base and select "Start" to reach the zero gap.

You will get this screen then zero will be done.



Once the zero gap has been found, the lift will automatically place the geometry at the memorized position.

Once this step is completed, go to the "Measure" tab by pressing "Home" button and then "Measure". You can pull up the measuring head by pressing the arrow upwards, leaving enough space to place your product to measure. Then place your product as explained in paragraph 5 and then press the "mem GAP" button. The measuring head will go to the measuring position. Remove excess product if necessary by using a nonmetallic soft tool with 90° angle.

You can make your measurement after that (see section 2.2.2)

4. VERIFICATION OF YOUR DEVICE

Your device has been calibrated and checked before delivery according to an internal procedure using a cylindrical MS DIN 11 mobile, an oil viscosity 1000 mPa.s and a temperature control system (EVA DIN) at 23 ° C.

We inform you that the cone-plane geometries are never used internally for our checks and calibrations. Indeed, this type of geometry can lead to measurement errors due, for example, to the problems of gap filling, slippage, product ejection or wrong gap distance.

You can nevertheless check your RM 200 CP4000 PLUS using your own geometry and a Newtonian standard oil of known and certified viscosity (preferably close to 1000 mPa.s). The tolerance on the accuracy of the viscosity measurement is at best 10% of the expected value with a cone-plane at a temperature whose viscosity value is known. Here is the procedure to follow for your verification:

Here is the procedure to follow for your verification:

- 1) Perform a motor zero (see section 2.2.5).
- 2) Warm up your geometry and the lower plane according to the procedure described in paragraphs 3.2 and 3.3.
- 3) Install your measuring system (see section 3.1).
- 4) Set Gap as described in section 3.3.
- 5) Put standard oil on lower plate and lowering measuring cone in measuring position (see section 3.1 to check good filling of gap).
- 3) Select a measurement method in manual mode by choosing a measuring time of 120s minimum and a shear of 100 s⁻¹ (see section 2.2.2).

The measured value must be within the tolerance of 10%. If the value is out of tolerance, check that all previous steps have been completed. If the problem persists, please contact LAMY RHEOLOGY.



LAMY RHEOLOGY

11 A, rue des Aulnes
69410 Champagne au Mont d'Or (France)

Tel : 33 (0)4 78 08 54 06

Fax : 33 (0)4 78 08 69 44

contact@lamyrheology.com

